

**GARMIN®**

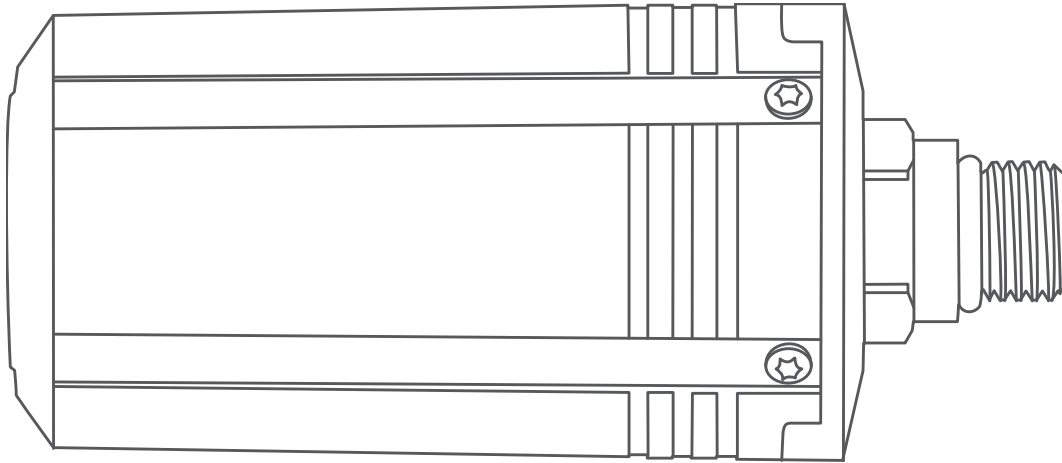

# DESCENT™ T2

---

Owner's Manual

© 2023 Garmin Ltd. or its subsidiaries

All rights reserved. Under the copyright laws, this manual may not be copied, in whole or in part, without the written consent of Garmin. Garmin reserves the right to change or improve its products and to make changes in the content of this manual without obligation to notify any person or organization of such changes or improvements. Go to [www.garmin.com](http://www.garmin.com) for current updates and supplemental information concerning the use of this product.

Garmin®, the Garmin logo, and ANT® are trademarks of Garmin Ltd. or its subsidiaries, registered in the USA and other countries. Descent™, Garmin Dive™, Garmin Express™, and SubWave™ are trademarks of Garmin Ltd. or its subsidiaries. These trademarks may not be used without the express permission of Garmin.

The BLUETOOTH® word mark and logos are owned by the Bluetooth SIG, Inc. and any use of such marks by Garmin is under license. Other trademarks and trade names are those of their respective owners.

M/N: A04770

# Table of Contents

<b>Introduction.....</b>	<b>1</b>
<b>Installation and Setup.....</b>	<b>1</b>
Transceiver Position Tips.....	1
Installing the Transceiver on Your Tank Regulator.....	4
Installing the Transceiver on a High Pressure Hose Extension.....	5
<b>Diving.....</b>	<b>7</b>
Dive Warnings.....	8
Waking the Transceiver from Low Power Mode.....	8
Pairing the Transceiver with a Descent Watch.....	9
Viewing Transceiver Data During a Dive.....	11
Updating the Transceiver Software Using Your Watch.....	11
Pairing the Transceiver with the Garmin Dive App.....	12
<b>Device Information.....</b>	<b>12</b>
Replacing the Descent T2 Transceiver Battery.....	12
Descent T2 Device Care.....	13
Specifications.....	13
<b>Troubleshooting.....</b>	<b>14</b>
Getting More Information.....	14
Dive Product and Feature Compatibility.....	14
Dive Terminology.....	14
Transceiver Alerts.....	15
My transceiver and watch lose connection underwater.....	15
My transceiver battery is draining rapidly.....	16
My transceiver makes an audible noise while diving.....	16



# Introduction

## ⚠ WARNING

See the *Important Safety and Product Information* guide in the product box for product warnings and other important information.

## Installation and Setup

### ⚠ CAUTION

To ensure proper setup and best performance, it is strongly recommended that you complete the first time installation and setup at a dive shop. You should fully test the transceiver installation above and below water before using it during a dive.

### Transceiver Position Tips

The transceiver communicates wirelessly with your compatible watch. On the surface, it uses ANT<sup>®</sup> technology. Underwater, it uses the SubWave™ sonar network. Your body, drysuit, and dive equipment can obstruct the signal, particularly while underwater. For the best reception, all transceivers in your group should have clear lines of sight to the watch. To help prevent blocking the signal with your body or equipment, you should follow these tips.

- You should install the transceiver on the same side of the tank as the wrist wearing your watch. For example, if you wear your watch on your left wrist, you should install the transceiver on the left side of the tank regulator.

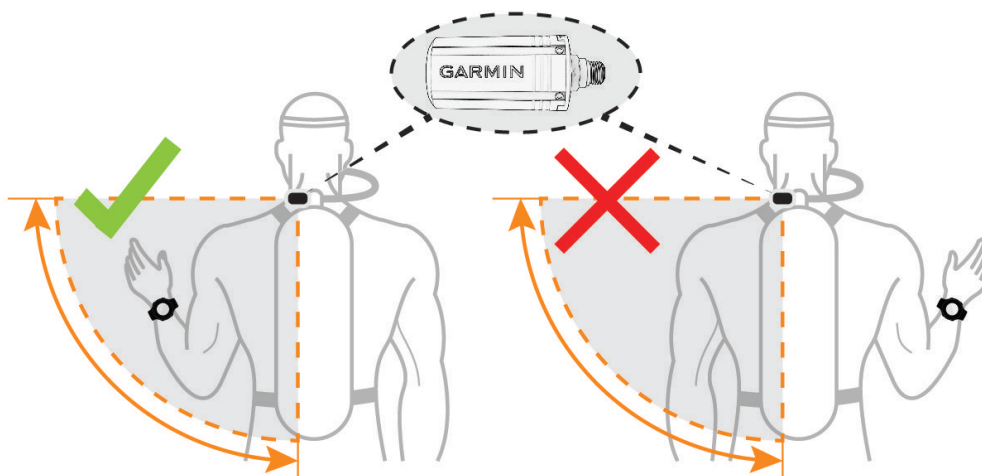

- For the best reception, you should wear the tank high on your back. This allows the transceiver to have a clear line of sight over your shoulders.

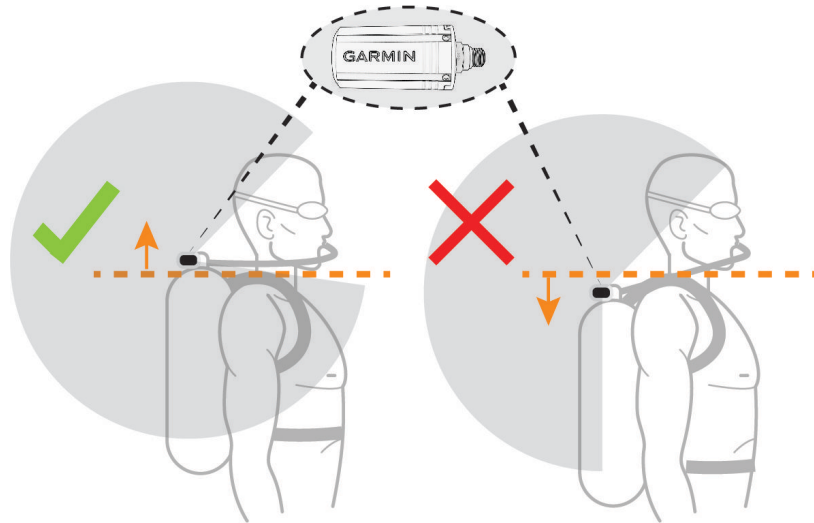

- You should install the transceiver at least 7 cm (3 in.) from your body.

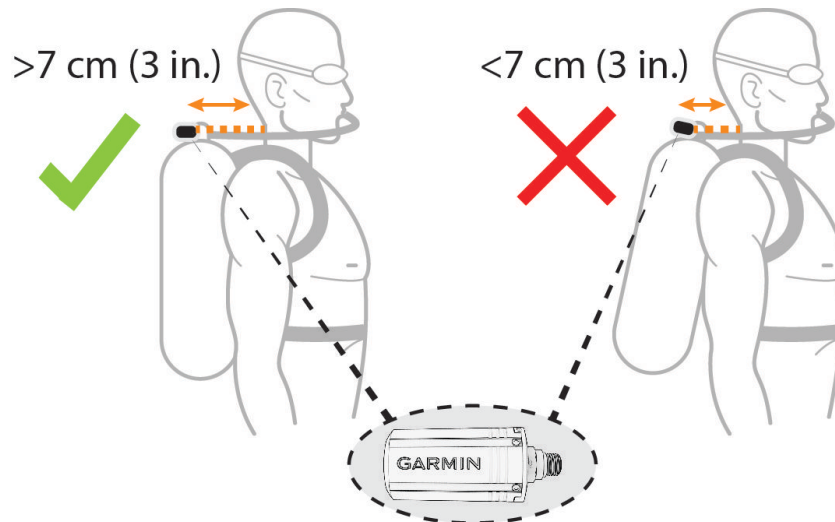

- If you wear your tank inverted with the regulator at the bottom, you can use a high-pressure hose to relocate the transceiver to have a clear line of sight over your shoulders.
- If you lose the signal from your transceiver, you should move your arm until the signal is restored.
- If you lose the signal from another diver, you should change your body position until the signal is restored. If your body is between the watch and another diver, it may obstruct the signal from that diver's transceiver.

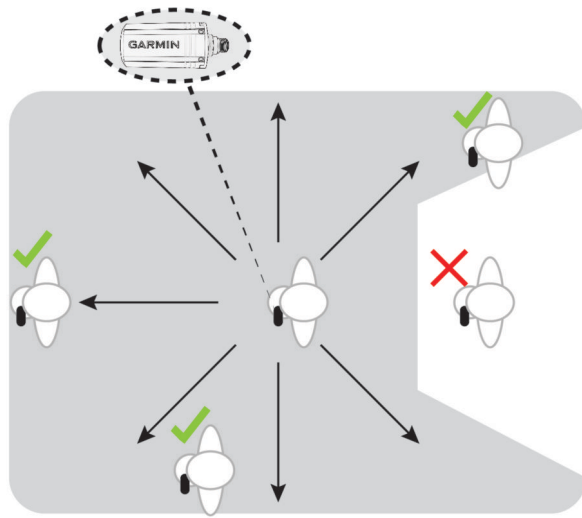

## Installing the Transceiver on Your Tank Regulator

### ⚠ WARNING

Always use the pre-installed flow restrictor when using the transceiver directly attached to your regulator. Always use the included air spool when connecting the transceiver to a high pressure hose extension (*Installing the Transceiver on a High Pressure Hose Extension, page 5*). Using the transceiver without either the flow restrictor or air spool could result in serious injury or death from an air pressurization failure.

Before you install the transceiver on your tank regulator, you should read the transceiver position tips and choose the port position that provides the best line of sight to the watch (*Transceiver Position Tips, page 1*).

- 1 Detach the first-stage regulator from the scuba cylinder and second-stage regulator.

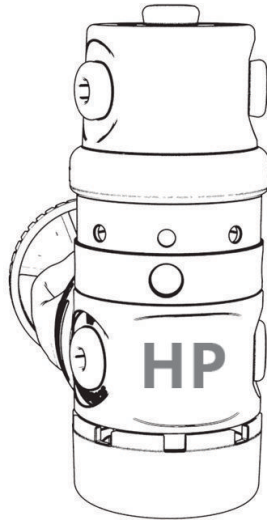

- 2 Remove the port plug from the high-pressure output port.
- 3 Confirm the flow restrictor is installed in the transceiver, and screw it into the high-pressure output port until it is secure.

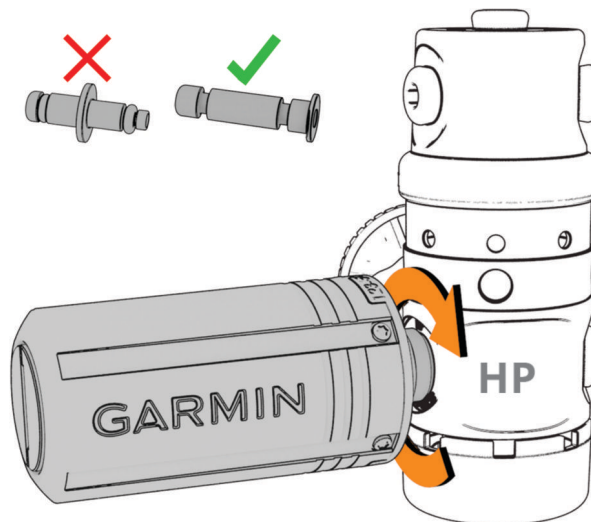

### ⚠ WARNING

Verify the installed transceiver does not physically interfere with any hoses or other tank assemblies.

### NOTICE

To prevent damage to the transceiver and possible loss of function, do not overtighten. Do not grip the regulator or the transceiver to move, carry, or adjust the tank.



## Installing the Transceiver on a High Pressure Hose Extension

### ⚠ WARNING

Always use the pre-installed flow restrictor when using the transceiver directly attached to your regulator (*Installing the Transceiver on Your Tank Regulator, page 4*). Always use the included air spool when connecting the transceiver to a high pressure hose extension. Using the transceiver without either the flow restrictor or air spool could result in serious injury or death from an air pressurization failure.

Before you install the transceiver on a high pressure hose extension certified to the EN 250:2014 standard, you should read the transceiver position tips and choose a position that provides the best line of sight to the watch (*Transceiver Position Tips, page 1*).

To install the transceiver, you need an open-ended wrench and a small flat screwdriver or flat-nose pliers.

- 1 Use a screwdriver or pliers to carefully remove the flow restrictor from the transceiver.

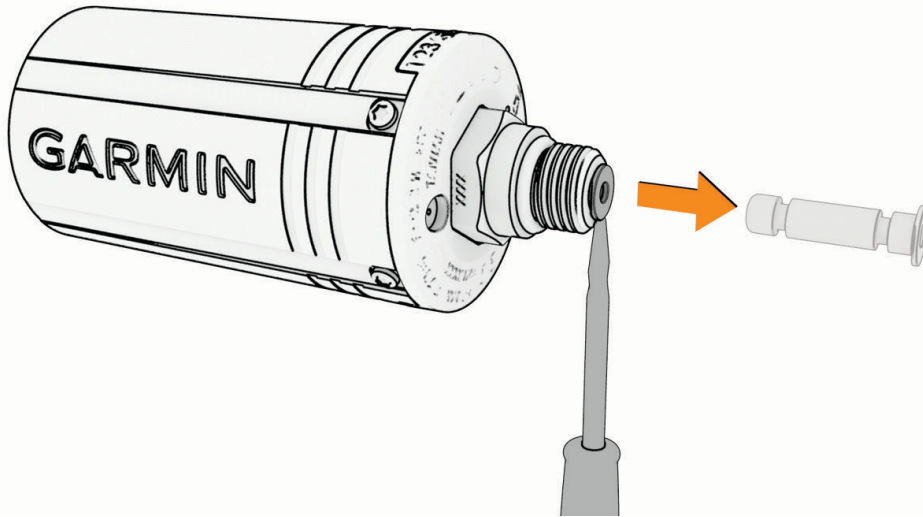

### NOTICE

Use care when removing the flow restrictor to avoid damaging the device.

- 2 Insert the large end of the air spool into the transceiver.

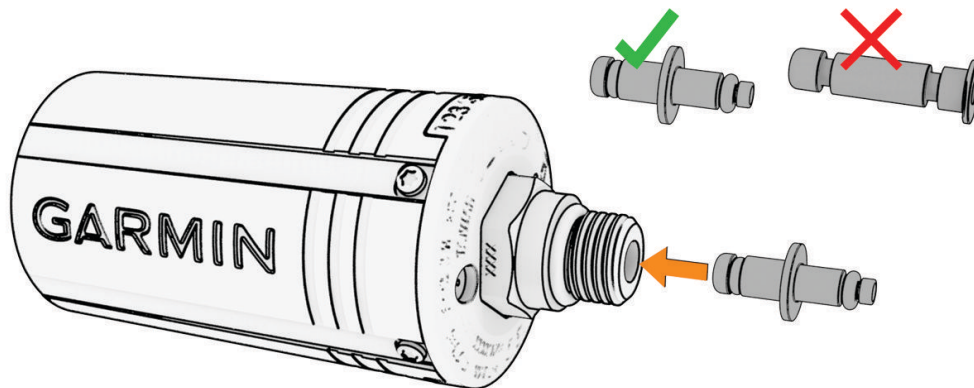

- 3 Detach the first-stage regulator from the scuba cylinder and second-stage regulator.

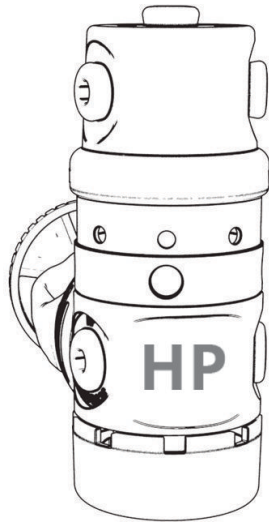

- 4 Remove the port plug from the high-pressure output port.
- 5 Connect a high-pressure hose extension to the high-pressure output port.

6 Screw the transceiver onto the high pressure hose extension until you feel resistance.

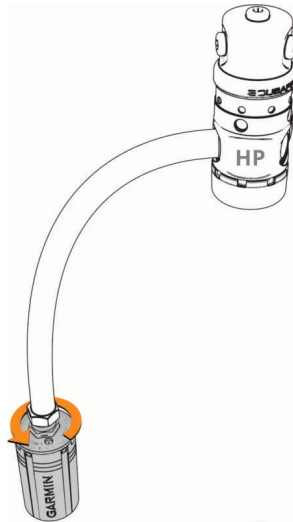

**WARNING**

Verify the installed transceiver does not physically interfere with any hoses or other tank assemblies.

7 Use an open-ended wrench to tighten the transceiver until it is secure.

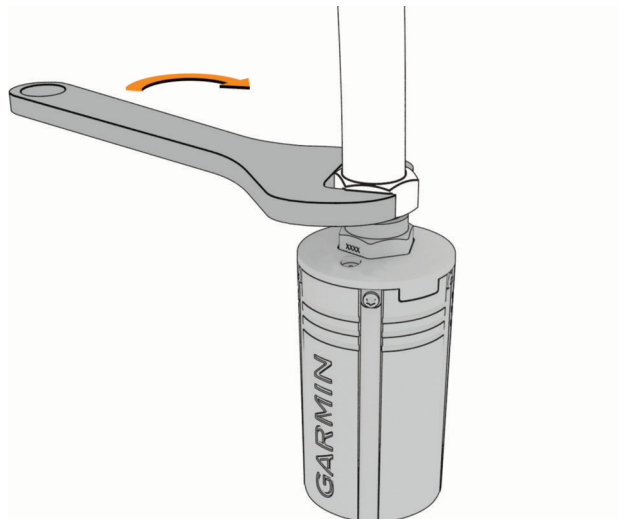

**NOTICE**

To prevent damage to the transceiver and possible loss of function, do not overtighten. Do not grip the regulator or the transceiver to move, carry, or adjust the tank.

You must remove the air spool and reinstall the flow restrictor before installing the transceiver on your tank regulator.

## Diving

You can use a compatible Descent watch paired with your Descent T2 transceiver to start a diving activity. See your Descent watch owner's manual for more information.

## Dive Warnings

### WARNING

- This device is for use by certified divers only.
- This device should not be used as the only source of pressure information. Always use backup instruments, including a depth gauge, submersible pressure gauge, and timer or watch.
- Make sure that you fully understand the use, displays, and limitations of your device. If you have questions about this manual or the device, always resolve any discrepancies or confusion before diving with the device. Always remember that you are responsible for your own safety.
- The dive computer can calculate your surface air consumption rate (SAC) and air time remaining (ATR). These calculations are an estimate and should not be relied on as the only source of information.
- Perform pre-dive safety checks, such as checking proper device function and settings, display function, battery level, tank pressure, and bubble checks to check hoses for leaks.
- If a tank pressure warning or battery warning appears on the dive computer, terminate the dive immediately and safely return to the surface. Disregarding the alarm may result in serious injury or death.
- For safety reasons, you should never dive alone. Dive with a designated buddy. You should also stay with others for an extended time after a dive, because the potential onset of decompression illness (DCI) may be delayed or triggered by surface activities.
- This device is not intended for commercial or professional dive activities. It is for recreational purposes only. Commercial or professional dive activities can expose the user to extreme depths or conditions that increase the risk of DCI.
- The transceiver is not an oxygen cleaned product. Do not use the transceiver with anything greater than 40% oxygen.

## Waking the Transceiver from Low Power Mode

Out of the box, the transceiver is in low power mode. You must wake the transceiver from low power mode to pair and connect to it.

Select an option:

- Install the transceiver on the first-stage regulator, and gradually open the tank valve to pressurize the regulator ([Installing the Transceiver on Your Tank Regulator, page 4](#)).  
**NOTE:** This option is not available for Bluetooth® pairing. Bluetooth technology is disabled when the transceiver is pressurized.
- Twist the battery cover counter-clockwise 270 degrees, wait 30 seconds, then twist the battery cover clockwise until it is secure.

The transceiver plays a tone when it wakes from low power mode and is ready to connect to your Descent watch ([Pairing the Transceiver with a Descent Watch, page 9](#)) or phone ([Pairing the Transceiver with the Garmin Dive App, page 12](#)).

## Pairing the Transceiver with a Descent Watch

Before you use the transceiver for the first time, you must pair it with the a compatible Descent watch using ANT technology.

For more information about compatible watch models, go to the Descent T2 transceiver product page on [garmin.com](http://garmin.com).

- 1 Wake the transceiver from low power mode (*Waking the Transceiver from Low Power Mode, page 8*).
- 2 On your Descent watch, hold **MENU**, and select **Dive Setup > Dive Network & Air Integration > Transmitters > Add New**.

The watch starts searching and displays a list of nearby transceivers.

- 3 From the list of transceivers, select the transceiver ID you want to pair.

The transceiver ID is printed on the housing.

When the pairing process is complete, the transceiver begins sending data, and it is ready to use on a dive. The next time the transceiver and watch are turned on and within wireless range, they connect automatically when you start a dive.

If you are diving with a group, you can pair up to 8 Descent transceivers with the watch.

## Transceiver Settings

You can customize the settings for paired transceivers prior to a dive.

On the paired Descent watch, hold **MENU**, select **Dive Setup > Dive Network & Air Integration > Transmitters**, and select a transceiver.

**Status:** Enables a connection to the transceiver, and shows the current connection status.

**Placement:** Sets the transceiver location as either your own tank or that of another diver.

**Public Tank Name:** Allows you to associate a name with your transceiver, which will be visible to your dive group.

**NOTE:** If you customize this name, another option appears in the list to clear the name.

**Nickname:** Allows you to associate a nickname with another user's transceiver, which will be visible on your dive data screens.

**NOTE:** If you customize this name, another option appears in the list to clear the name.

**Identify:** Plays a tone on the selected paired transceiver. This helps you to identify the transceiver without needing to look at the transceiver ID printed on the transceiver housing.

**Working Pressure:** Sets how much pressure the tank has when full. This value is used to determine the upper end of the pressure gauge, and to calculate respiratory minute volume (RMV) for tanks using psi units.

**Reserve Pressure:** Sets the threshold values for reserve pressure and critical pressure alerts to appear on the watch.

**Volume:** Allows you to enter the air volume of the tank. You can use the Reset Volume option if you move the transceiver to a different size tank.

**NOTE:** This value is required to calculate volumetric surface air consumption (SAC) and respiratory minute volume (RMV) (*Selecting the Gas Consumption Rate Metric, page 10*).

**SAC/RMV/ATR:** Enables the transceiver to be included in volumetric surface air consumption (SAC), respiratory minute volume (RMV), and air time remaining (ATR) estimates (*Including Transceivers in Gas Consumption Calculations, page 10*).

**Set Transmit Power:** Allows you to adjust the power setting if your transceiver is losing connection with the paired watch underwater.

**About:** Displays the transceiver ID, software version, and battery status.

**Remove:** Allows you to remove a paired transceiver.

## Selecting Transceivers to View During a Dive

You can view two paired transceivers at-a-glance on the primary dive data screen. You can customize which paired transceivers appear on the screen. By default, the first and second transceivers that you pair appear ([Viewing Transceiver Data During a Dive, page 11](#)).

- 1 On the paired Descent watch, hold **MENU**.
- 2 Select **Dive Setup > Dive Network & Air Integration > Display Setup**.
- 3 Select a field to customize.
- 4 Select a paired transceiver.

## Selecting the Gas Consumption Rate Metric

- 1 On the paired Descent watch, hold **MENU**.
- 2 Select **Dive Setup > Dive Network & Air Integration > Display Setup > Gas Consumption Rate**.
- 3 Select an option.  
**NOTE:** The watch can estimate volumetric surface air consumption (SAC) or respiratory minute volume (RMV) only if the air volume of the tank is entered in the watch ([Transceiver Settings, page 9](#)). The watch can estimate pressure-based surface air consumption (PSAC) with or without the air volume of the tank.

## Including Transceivers in Gas Consumption Calculations

Gas consumption and air time remaining estimates are calculated using the tank pressure from the included transceivers. By default, the first transceiver that you pair with your compatible dive computer is included. You can include additional paired transceivers in gas consumption calculations.

- 1 On the paired Descent watch, hold **MENU**.
- 2 Select **Dive Setup > Dive Network & Air Integration > Transmitters**.
- 3 Select a paired transceiver.
- 4 Select the **SAC/RMV/ATR** toggle switch to include the transceiver in gas consumption calculations.
- 5 If necessary, repeat steps 2 through 4 to include additional paired transceivers in gas consumption calculations.

## Viewing Transceiver Data During a Dive

1 During a dive, press **DOWN** on your paired Descent watch to view the data screen.

**TIP:** You can customize the dive data screens to view the transceiver and diver dashboard data on dedicated data screens.

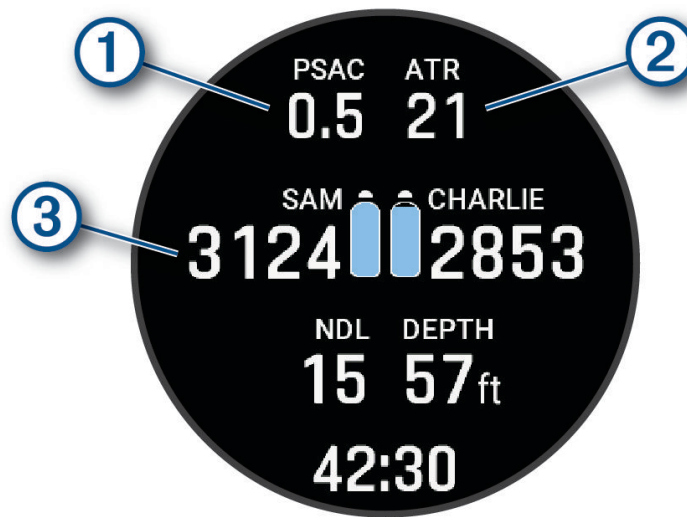

The gas consumption estimate for the selected transceivers.

① **NOTE:** You can customize the transceivers used for gas calculations (*Including Transceivers in Gas Consumption Calculations*, page 10).

② The air time remaining (ATR) estimate for the selected transceivers.

Your primary and secondary transceivers and their tank pressure values.

③ **NOTE:** You can customize which transceivers are displayed (*Selecting Transceivers to View During a Dive*, page 10).

2 Press **START**, and select **Divers** to view the tank pressure values and approximate depths of the paired Descent transceivers in the network.

## Updating the Transceiver Software Using Your Watch

Before you can update the software, you must pair your Descent T2 transceiver to a compatible Descent watch.

1 Select an option to sync your watch:

- Sync your watch with the Garmin Dive™ app.
- Connect the watch to your computer using the USB cable, and sync with the Garmin Express™ application.

The Garmin Dive app and Garmin Express application automatically look for software updates. When you sync with the Garmin Dive app, you will be prompted to apply the update at a later time. When you sync with the Garmin Express application, the update is applied immediately to your watch.

2 Wake the transceiver from low power mode (*Waking the Transceiver from Low Power Mode*, page 8).

3 On the paired Descent watch, hold **MENU**, select **Dive Setup > Dive Network & Air Integration > Transmitters**, and select your transceiver.

4 Wait for the transceiver to connect to your watch.

**Connected** appears on the watch screen.

5 Select **Update Available**, press **START**, and select **Install Now**.

**NOTE:** The Update Available option may take up to a minute to appear while the watch determines the transceiver's software version and battery status. If the battery status is low or critically low, you must replace the battery before you can install the update.

6 Keep the watch near the transceiver until the software update is complete.

## Pairing the Transceiver with the Garmin Dive App

You can pair the transceiver with the Garmin Dive app to receive software updates using Bluetooth technology.

- 1 Wake the transceiver from low power mode ([Waking the Transceiver from Low Power Mode, page 8](#)).
- 2 Scan the QR code on the transceiver with the camera on your phone, and follow the on-screen instructions to complete the pairing and setup process.

The transceiver is in pairing mode for two minutes, then it goes back into low power mode.

## Device Information

### Replacing the Descent T2 Transceiver Battery

#### NOTICE

You should purchase a replacement battery only from a high-quality manufacturer and a reputable vendor. Using a low-quality battery could result in poor product performance and reduced battery life, especially at low temperatures. Do not use rechargeable batteries. Rechargeable batteries may have a higher voltage specification and can cause permanent damage to the device.

To replace the battery, you need a coin or flat screwdriver, a new 3 V CR123A lithium battery, and waterproof silicone grease. You may also need a replacement battery cap accessory.

The transceiver is powered by a 3 V CR123A lithium battery. A battery is pre-installed at the factory. You must carefully follow the battery replacement instructions to preserve the transceiver's waterproofing.

- 1 Insert a coin or flat screwdriver into the slot ①, and rotate counter-clockwise to unscrew the battery cap.

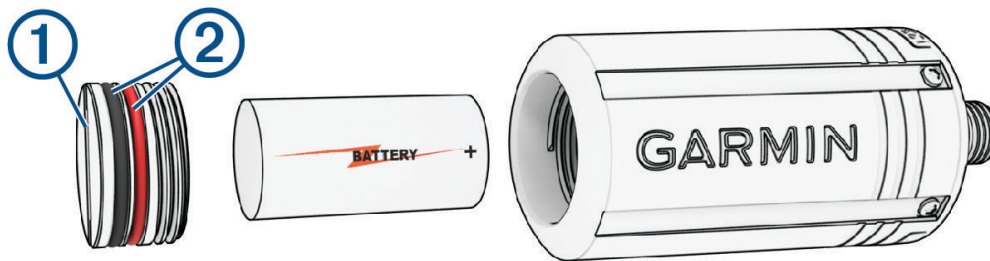

- 2 Remove the battery cap and battery.
- 3 Insert the new battery in the transceiver, with the positive pole facing into the transceiver and the negative pole facing the battery door.
- 4 Inspect both gaskets ② to verify they are clean, undamaged, and fully seated in the grooves.  
If the gaskets appear worn or damaged, you can purchase a replacement battery cap kit, including a cap, gaskets, and silicone grease. Go to the Descent T2 product page on [garmin.com](http://garmin.com) to purchase accessories.
- 5 Apply a thin layer of waterproof silicone grease to both gaskets.
- 6 Replace the battery cap into the transceiver, and fully tighten it.



## Descent T2 Device Care

### NOTICE

Do not grip the regulator or the device to move, carry, or adjust the air tank.

Do not remove the safety plug from the base of the device.

Do not use a sharp object to clean the device.

Avoid chemical cleaners, solvents, and insect repellents that can damage plastic components and finishes.

Thoroughly rinse the device with fresh water after exposure to chlorine, salt water, sunscreen, cosmetics, alcohol, or other harsh chemicals. Prolonged exposure to these substances can damage the case.

Avoid extreme shock and harsh treatment, because it can degrade the life of the product.

Do not store the device where prolonged exposure to extreme temperatures can occur, because it can cause permanent damage.

Discontinue use if the device is damaged or if it is stored at a temperature outside the specified storage temperature range.

Discontinue use if there is water ingress into the battery compartment. Even small amounts of water can cause corrosion of the electrical contacts.

### Cleaning the Transceiver

- 1 After each dive, rinse the transceiver with fresh water to remove salt and debris.
- 2 If necessary, clean the transceiver with a soft cloth.

### Replacement Parts

Replacement parts are available for this device. Contact your Garmin® dealer or go to [garmin.com](http://garmin.com) for more information.

### Specifications

Battery	3 V CR123A lithium
Battery life	Up to 100 hr.
Thread type	$\frac{7}{16}$ in. (20 UNF)
Operating temperature range	From -20 to 60°C (from -4 to 140°F)
Underwater operating temperature range	From 0 to 40°C (from 32 to 104°F)
Storage temperature range	From -30 to 70°C (from -22 to 158°F)
Wireless frequency	2.4 GHz @ 5.22 dBm maximum
Surface transmission range (ANT and Bluetooth technology)	Up to 10 m (33 ft.)
Underwater transmission range (SubWave sonar network)	Pressure and depth data: up to 10 m (33 ft.)
Water rating	20 ATM <sup>1</sup>
Pressure rating	300 bar (4351 psi)
Inspection interval	Inspect parts before each use for damage. Replace parts as needed. <sup>2</sup>

<sup>1</sup> The device withstands pressure equivalent to a depth of 200 m. For more information, go to [www.garmin.com/waterrating](http://www.garmin.com/waterrating).

<sup>2</sup> Aside from normal wear and tear, performance is not affected by aging.

# Troubleshooting









## Getting More Information

You can find more information about this product on the Garmin website.

- Go to [support.garmin.com](http://support.garmin.com) for additional manuals, articles, and software updates.
- Go to [buy.garmin.com](http://buy.garmin.com), or contact your Garmin dealer for information about optional accessories and replacement parts.

## Dive Product and Feature Compatibility

You can pair multiple Descent devices to form a dive network for you and your fellow divers.

	Descent T1 with 2.xx software or earlier	Descent T1 with 3.xx software or later	Descent T2
Descent Mk2i with 20.40 software or earlier	 <ul style="list-style-type: none"> <li>• View tank pressure</li> <li>• View diver depth</li> </ul>	 <ul style="list-style-type: none"> <li>• No network connection</li> </ul>	 <ul style="list-style-type: none"> <li>• No network connection</li> </ul>
Descent Mk2i with 22.00 software or later	 <ul style="list-style-type: none"> <li>• View tank pressure</li> <li>• View diver depth</li> </ul>	 <ul style="list-style-type: none"> <li>• View tank pressure</li> <li>• View diver depth</li> <li>• View public tank name</li> </ul>	 <ul style="list-style-type: none"> <li>• View tank pressure</li> <li>• View diver depth</li> <li>• View public tank name</li> </ul>
Descent Mk3i	 <ul style="list-style-type: none"> <li>• View tank pressure</li> <li>• View diver depth</li> </ul>	 <ul style="list-style-type: none"> <li>• View tank pressure</li> <li>• View diver depth</li> <li>• View public tank name</li> </ul>	 <ul style="list-style-type: none"> <li>• View tank pressure</li> <li>• View diver depth</li> <li>• View public tank name</li> </ul>

: View tank pressure for yourself and connected divers.

: View diver depth for connected divers.

: View the public transceiver names for yourself and connected divers.

: No dive network connection. You should update both of your devices to the latest software versions. The following alert appears on the watch: Transmitter %1 failed to connect.. "%1" is replaced with the transceiver name.

## Dive Terminology

**Air time remaining (ATR):** The time you may remain at the current depth until an ascent at 9 m/min. (30 ft./min.) would result in surfacing with the reserve pressure.

**Pressure-based surface air consumption (PSAC):** The change in pressure over time, normalized to 1 ATM.

**Respiratory minute volume (RMV):** The change in gas volume at ambient pressure over time.

**Volumetric surface air consumption (SAC):** The change in gas volume over time, normalized to 1 ATM.

## Transceiver Alerts

Alert Message	Cause	Device Action
None	Your paired watch has lost communication with the transceiver for 30 seconds.	The tank pressure value flashes yellow.
%1 is below reserve pressure.	Your tank pressure is below the reserve pressure level. "%1" is replaced with the transceiver name.	The tank pressure value turns yellow. The paired watch vibrates and plays a warning tone.
%1 pressure is critically low.	Your tank pressure is below the critical pressure level. "%1" is replaced with the transceiver name.	The tank pressure value flashes red. The paired watch vibrates and plays a warning tone.
%1 has a low battery.	Fewer than 20 hours of dive time remain. "%1" is replaced with the transceiver name.	The transceiver name flashes BATT. LOW when the battery is critically low. The paired watch vibrates and plays a warning tone.
NO COMMS	Your paired watch has lost communication with the transceiver for 60 seconds.	The transceiver name flashes NO COMMS, dashed lines replace the tank pressure value, and the tank pressure value flashes red. The paired watch vibrates and plays a warning tone if connection alerts are enabled.
Transmitter %1 failed to connect.	Your paired watch cannot connect to the transceiver. You should update both devices to the latest software version. "%1" is replaced with the transceiver name.	The paired watch vibrates and plays a warning tone.

### Enabling Lost Transceiver Alerts

Your paired watch can lose communication with the transceiver when the transceiver is out of range, when the transceiver signal is blocked by your body or that of another diver, and when the transceiver loses battery power. You can enable an alert that notifies you when your paired watch has lost communication with the transceiver for 60 seconds.

- 1 On the paired watch, hold **MENU**.
- 2 Select **Dive Setup > Dive Network & Air Integration > Connection Alert**.

### My transceiver and watch lose connection underwater

If your watch and transceiver communicate on the surface but lose communication underwater, you can try these tips.

- Increase the transceiver power setting ([Adjusting the Transceiver Power Setting, page 16](#)).
- Install the transceiver on a high pressure hose extension to improve the line of sight between the transceiver and the watch ([Installing the Transceiver on a High Pressure Hose Extension, page 5](#)).
- Follow the transceiver position tips to achieve the best line of sight between the watch and the transceiver ([Transceiver Position Tips, page 1](#)).

## Adjusting the Transceiver Power Setting

**NOTE:** Increasing the power setting increases the audible noise and transmission range of the transceiver and decreases its battery life.

- 1 Hold **MENU**.
- 2 Select **Dive Setup > Dive Network & Air Integration > Transmitters**.
- 3 Select a paired transceiver.
- 4 Select **Set Transmit Power**.
- 5 Enter the transceiver ID.  
**NOTE:** The transceiver ID is printed on the housing.
- 6 Select an option.

## My transceiver battery is draining rapidly

If your transceiver battery is draining faster than the expected battery life ([Specifications, page 13](#)), you should make sure the transceiver is returning to low power mode after a dive.

When you return to the surface after a dive, depressurize your regulator.

The installed transceiver enters low power mode after two minutes have elapsed.

## My transceiver makes an audible noise while diving

The transceiver makes an audible noise when transmitting data over the SubWave sonar network during normal operation. Sonar signals are noticeable while diving, and because sound travels better through water than radio waves, the SubWave sonar network has longer range than traditional radio-based products. The SubWave sonar network uses a lower power signal (1 W to 10 W) than traditional marine sonar systems (around 1000 W). Testing has not indicated any disturbance to sea life.

You can decrease the power setting to reduce the audible noise from the transceiver ([Adjusting the Transceiver Power Setting, page 16](#)).



